

Varenummer: 3901150020500
 Beskrivelse: Snekkegear med fri indgangsaksel
 VF 150FC-20-HS

Mål

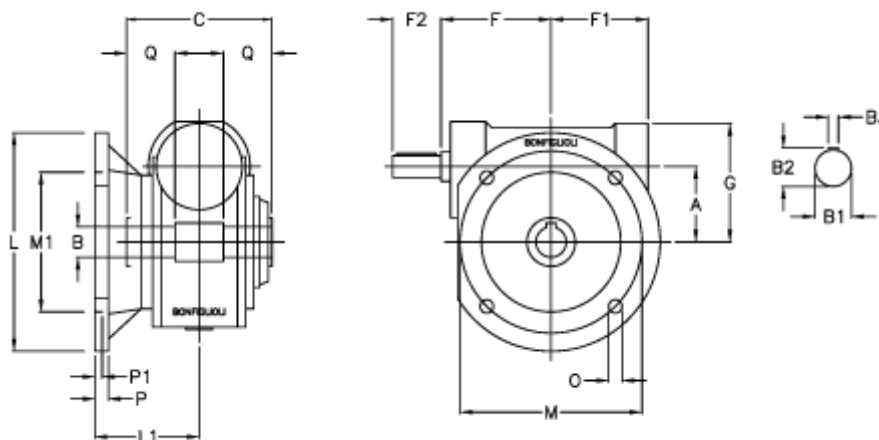

a	= 150.0	F1	= 179	P	= 22
B	= 50	F2	= 65	P1	= 13
B1	= 35	g	= 218	Q	= 55.0
B2	= 38	L	= 350		
B3	= 10	L1	= 145.5		
Betegnelse	= VF 150FC-xx-HS	m	= 290		
C	= 175	M1	= 200		
F	= 185.0	O	= 18		